













MANILOADER

■ **ML 40**



- Load capacity: 1500 kg
- Overall height: 1.96 m or 1.87 m
- ROPS/FOPS driver protection
- Engine: 50 HP
- Standard bucket: 400 L
- Articulated chassis

ML 40

-  **Load capacity**1500 kg
-  **Lifting height**
Under the forks2.60 m
Unloading height.....1.95 m
-  **Tyres**
Standard10 x 16.5 10 PR SKS
-  **Accessories**
Pallet forks
Manure forks1.47 m or 1.80 m
BucketsWidth - Capacity
Earth moving.....1.30 m - 400 L
Multifunction 4x11.50 m - 450 L
Light material.....1.80 m - 600 L
Light material.....2 m - 1000 L
Unloading 3.20 m1.30 m - 400 L
-  **Oil-immersed brakes with negative control on all four wheels**
-  **KUBOTA engine**
Type.....4 cylinders - Turbo
Rated speed2800 rpm
Power (ISO/TR14396)50 HP/38 kw
Max. torque143 Nm at 1800 rpm
Indirect injection
Water cooled
-  **Transmission**hydrostatic
Electrohydraulic gear reverser
Gears: 1 forward and 1 reverse
Max. speed22 km/h
-  **Axles**
Front rigid self-locking
Rear oscillating self-locking
Epicyclic reducers
-  **Steering**
Articulated chassis, 2 two-way cylinders
-  **Hydraulics**
Main gear pump50 L/min
Hydraulic pressure230 bar
-  **Fuel tank**60 L
-  **Weight unladen** (no accessories).....2900 kg
Overall width.....1300 mm
Overall height.....1960 mm
Low-frame option.....1870 mm
Turning circle3160 mm
Turning circle240 mm
Tractive effort (loaded)2330 daN

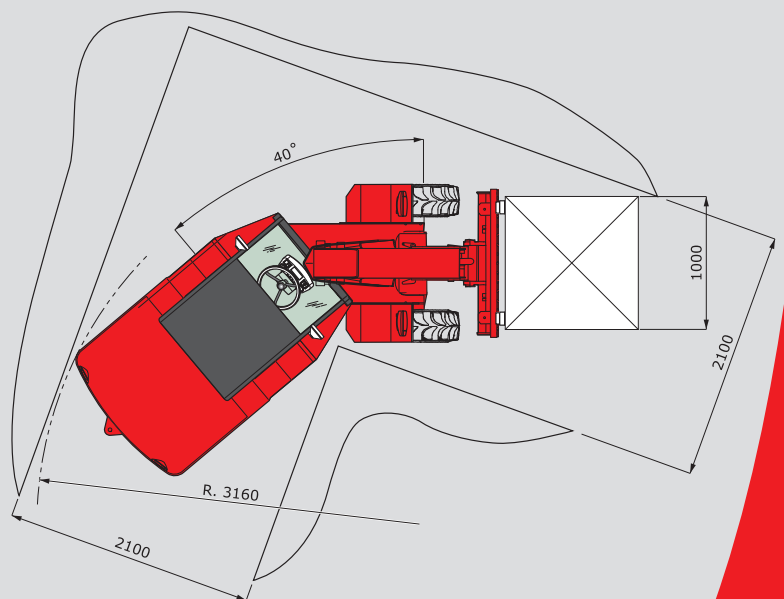
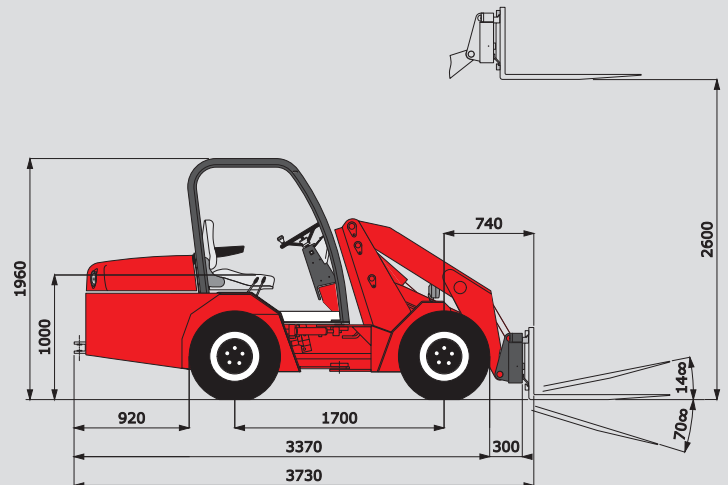
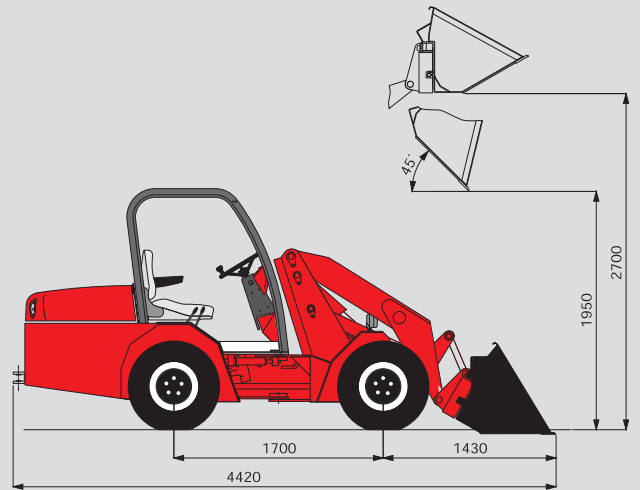

This publication in no way constitutes an offer and the company reserves the right to alter specification without prior notice.
The MANITOU models presented in this brochure can be supplied complete with optional equipment attachments.

MANITOU BF SA

B.P. 249 - 44158 Ancenis Cedex - France
Tél. : 33 2 40 09 10 11 / Export Department Fax : 33 2 40 09 10 97
www.manitou.com

700386EN-A - 04/07

